

MEGA

K O N T R O L

ÜRÜN KATALOĐU

Product Catalogue



MEGA

KONTROL

Enerji, Tekstil ve Gıda Sektörü başta olmak üzere birçok endüstri alanında kullanılan ürünlerimizi;

Yüksek kaliteli ve uygun fiyata sunuyoruz.

Firmamız müşteri odaklılık felsefesi ile,

Başta vanalar, solenoid vanalar ve aktüatörler olmak üzere, contalar, paslanmaz ürünler, manometreler, kondensstoplar, tubing, boru ve kaynak bağlantı elemanları olmak üzere;

Kalite ve doğru ürün hizmetini bir arada olacak şekilde,

uzun ömürlü, az bakım maliyeti gerektiren ürünleri sunmaktadır.

Our products are used in many industrial areas, especially in the Energy, Textile and Food Sectors;

We offer high quality products and at affordable prices.

Our company is customer oriented and continues to offer quality and the right product service together.

Especially valves, solenoid valves and actuators, as well as gaskets, stainless products, manometers, steam traps, tubing, pipe and welding fittings;

We offer our customers products that are long-lasting and require low maintenance costs.



Web Sitemizi ziyaret edin.

Visit our Website.

www.megakontrol.com



İÇİNDEKİLER Index

- **Enstrumantasyon Küresel Vanalar / Instrumentation Ball Valves**
- **Spiral Sarımlı Contalar / Spiral Wound Gaskets**
- **Manometreler / Manometers**
- **Pnömatik Aktüatörler / Pneumatic Actuators**
- **Elektrik Aktüatörler / Electric Actuators**
- **Vanalar / Valves**
- **Solenoid Valfler / Solenoid Valves**
- **Kondenstoplar / Steam Traps**
- **Kontrol Vanaları / Control Valves**
- **Kelebek Vanalar / Butterfly Valves**
- **Paslanmaz Grubu / Stainless Group**
- **Tube, Boru ve Kaynak Bağlantı Elemanları / Tube, Pipe and Weld Fittings**
- **Kompansatörler ve Hortumlar / Expansion Joints and Hoses**
- **Petrol Sahası ve Akış Hattı Ürünleri / Oilfield and Flowline Products**
- **Basıncılı Ekipmanlar / Pressure Vessels**



ENSTRUMANTASYON KÜRESEL VANALAR

INSTRUMENTATION BALL VALVES

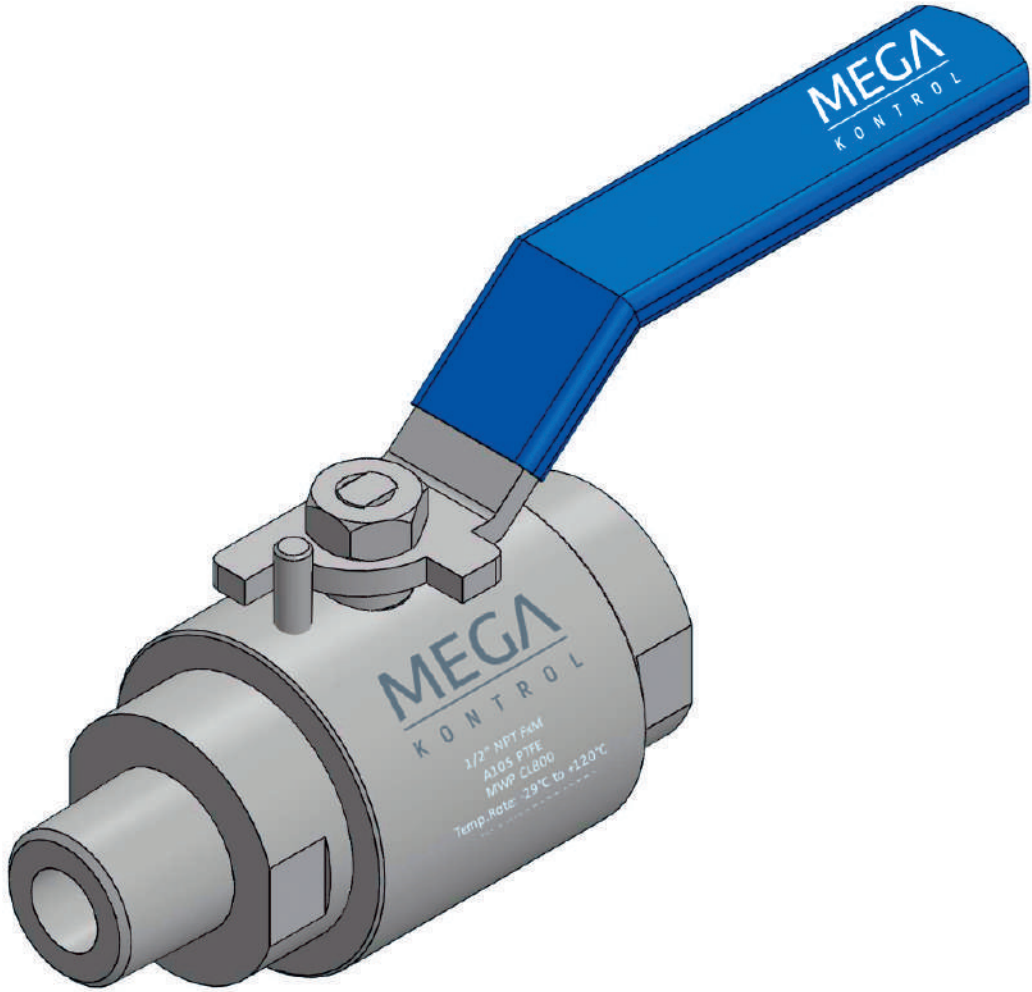

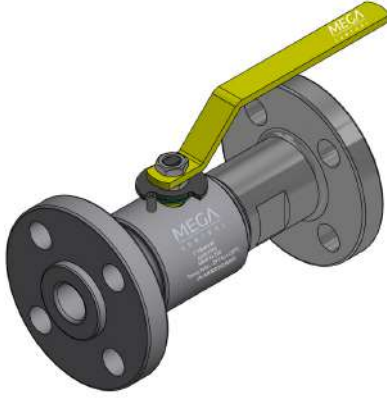

FxM / FXF / RFxRF TS EN ISO 17292 Küresel Vanalar

Fluid : Oil / Gas

Pressure Class : ANSI 800 - ANSI 150 to ANSI 1500

DN, Size : 1/2" - DN 15 / 1" - DN 25 / 2" - DN 50

Temperature Class : -29°C to +100°C acc. to ASME B16.34

End Connection : FNPT X MNPT / FNPT x FNPT / RF x RF

Standard : EN ISO 17292 / API 6D

Bore Type : Full Bore / Reduced Bore

Body Type : Split Body

Mounted Type : Floating

Fire Safe : Acc. to ISO 10497 / API 6FA

Face to Face : EN ISO 17292

Operator : Lever / Actuator

Test : TS EN 17292 / API 598

Material : A105 Body, Stainless Steel Trim, PTFE Seat



MEGA Kontrol olarak, müşterilerimize üstün kaliteli, kullanışlı ve ekonomik ürünler sunmaktayız.

Her ürünle birlikte aşağıdakileri gönderiyoruz;

- 2.1, 3.1/3.2 sertifikaları ile ürün datasheetleri / teknik çizimleri,
- ürün basıncı ve fonksiyon testi raporları,
- kullanım ve bakım kılavuzları.

MEGA Kontrol, offers superior quality, useful and economical products to our valued customers. We send the following to our customers with each product;

- 2.1, 3.1 / 3.2 certificates and datasheet / technical drawings,
- product pressure and function test reports,
- use and maintenance manuals.

Firmamız aşağıdaki sertifikalara sahiptir;

- Kalite Yönetim Sistemi (ISO 9001),
- Çevre Yönetim Sistemi (ISO 14001),
- İş Sağlığı ve Güvenliği Yönetim Sistemi (ISO 45001),
- Bilgi Güvenliği Yönetim Sistemi (ISO 27001)

Ürünlerimiz aşağıdaki sertifikalara sahiptir;

- TS EN ISO 17292 Sertifikası
- ISO 10497 Fire Safe Sertifikası
- ISO 14141 Performans Testi Sertifikası
- ISO 15148 Fugitive Emission Sertifikası
- CE PED Basıncı Ekipman Sertifikası
- SIL 3 Sertifikası

Our company has the following certifications;

- Quality Management System (ISO 9001),
- Environmental Management System (ISO 14001),
- Occupational Health and Safety Management System (ISO 45001),
- Information security management systems (ISO 27001)

Our products have the following certificates;

- TS EN ISO 17292 Certificate
- ISO 10497 Fire Safe Certificate
- ISO 14141 Performance Test Certificate
- ISO 15148 Fugitive Emission Certificate
- CE PED Pressure Equipment Certificate
- SIL 3 Certificate



SPIRAL SARIMLI CONTALAR

SPIRAL WOUND GASKETS



¼" ten 24" e kadar, ANSI 150'den ANSI 2500'e / PN 6 dan PN 400'e kadar Spiral Sarımlı Contalar
Spiral Wound Gaskets from ¼" to 24", ANSI 150 to ANSI 2500 / PN 6 to PN 400

Mega Kontrol spiral sarımlı conta, V şekilli Metal şerit ve soft non-metallic dolgudan oluşur. Spiralin içindeki ve dışındaki destek halkaları contanın tutuşunu, takılmasını ve çok yönlülüğünü artırır.

Mükemmel basınç dayanımına bağlı olarak sıcaklık ve basınç değişiminin sık olduğu noktaların yalıtımı için uygundur.

Mega Kontrol spiral wound gasket consists of V-shaped metal strip and soft non-metallic filling. Support rings inside and outside the spiral increase seal retention, fit and versatility.

Due to its excellent pressure resistance, it is suitable for the insulation of points where temperature and pressure changes occur frequently.

MK-SWG-600-S Basic Type

Temel yapı tipi, iç ve dış çaplar, daha fazla stabilite ve daha iyi sıkıştırma özellikleri sağlamak için dolgusuz birkaç metal yığınla güçlendirilmiştir. Tongue ve oluk, erkek ve dişi veya yivli ile düz yüzlü flanş düzenekleri için uygundur.

Basic construction type, inner and outer diameters are reinforced with several piles of metal without filler to give greater stability and better compression characteristics. - Suitable for tongue and groove, male and female or grooved to flat face flange assemblies.

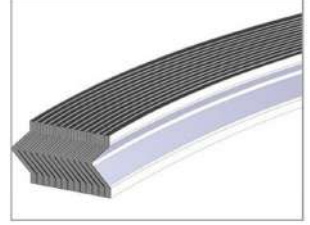

MK-SWG-600-SI Inner Ring Type

Sağlam iç metal halka, sıkıştırma durdurucu görevi görür. Katuların birikmesini önlemek, proses sıvılarının türbülanslı akışını azaltmak ve erozyonu, flanş deliği ile iç çap arasındaki conta hasarlarını en aza indirmek için halka şeklindeki boşluk, sağlam iç metal halka ile doldurulur. Erkek ve dişi boru flanşlarına uygundur.

Solid inner metal ring acts as a compression stopper. To prevent accumulation of solids, reduce turbulent flow of process fluids and minimize erosion, damages of gasket between flange bore and the inside diameter, the annular space is filled up by solid inner metal ring. - Suitable for male and female pipe flanges.

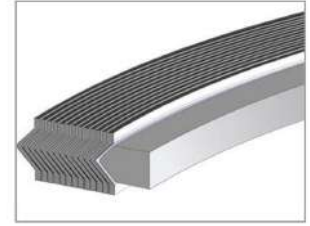

MK-SWG-600-GS Outer Ring Type

Katı dış halka, contanın patlamasını önlemek için ek radyal güç sağlamak üzere contayı flanş yüzeyinde doğru bir şekilde konumlandırır ve bir sıkıştırma sınırlayıcı görevi görür. Dış bileziğin takılması durumunda, dış bileziğin ucu cıvatalara temas edeceği için contayı flanş yüzüne takmak çok kolaydır. Düz yüzlü ve yükseltilmiş yüzlü flanşlarla kullanıma uygundur. Class 900 ve üzeri için dahili bir halka önerilir.

Solid outer ring accurately locates the gasket on the flange face to give the additional radial strength to prevent the gasket blowout and acts as a compression limiter. In case of installing the outer ring, it is very easy to install the gasket to flange face because the end of outer ring will touch at bolts - Suitable for use with flat face and raised face flanges. For class 900 and above an internal ring is recommended.



MK-GSI Inner & Outer Rings Type

Bir iç halka ve dış halka tipi conta, contanın iç ve dış tarafı için ek bir sıkıştırma sınırlayıcı durdurucu sağlayacaktır. Flanş yüzündeki halkasal boşluktaki korozyonları önleyecektir. - Düz yüzlü ve yükseltilmiş yüzlü flanşlarla kullanıma uygundur ve yüksek basınç/sıcaklık hizmeti için belirtilmiştir. Class 900 ve üzeri veya aşındırıcı veya toksik ortamların mevcut olduğu yerler.

An inner ring and outer ring type gasket will give an additional compression limiting stopper for gasket inner and outer side. It will prevent the corrossions on flange face at annular space. - Suitable for use with flat face and raised face flanges and specified for high pressure / temperature service - Class 900 and above or where corrosive or toxic media are present.

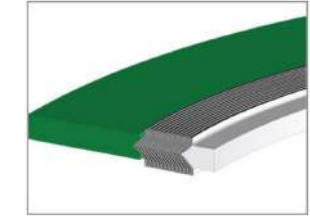

Başlıca Özellikler

- Çok çeşitli boyut ve şekiller,
- Metal şerit ve dolgu kombinasyonları, özel akışkan ortamına ve çalışma koşullarına uyum,
- Hızlı kurulum ve kaldırma,
- Düz veya yükseltilmiş flanş yüzeylerinde yüksek boru hattı basıncına uygun contalar,
- Kriyojenik sıcaklıktan 1000 °C'ye kadar sıcaklıklar.

Main Features

- A wide variety of sizes and shapes,
- Metal strip and filler combinations, adaptability to special fluid environment and operating conditions,
- Quick installation and removal,
- Gaskets suitable for high pipeline pressure on flat or raised flange surfaces,
- Temperatures from cryogenic to 1000 °C.



MANOMETRELER

PRESSURE GAUGE





**Paslanmaz
Manometreler**
Stainless Steel Manometers

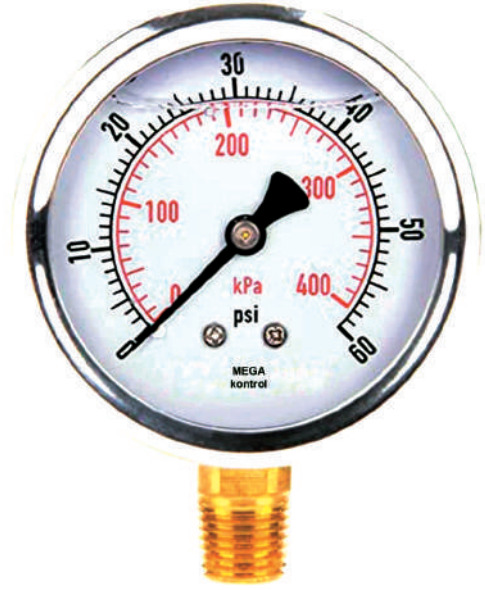

**Pirinç Mekanizmalı
Manometreler**
Brass Mechanism Manometers

Kaliteli, Uygun Fiyatlı ve Dayanıklı MEGA Kontrol Manometreleri

Nominal Boyutlar mm olarak / Nominal Sizes in mm : 63, 100, 160

Ölçek Aralıkları / Scale Ranges :

- NS 63: 0...1 bar'dan 700 bar'a
- NS 100, 160: 0...0,6 bar ila 700 bar

Basınç Sınırlamaları / Pressure Limitations :

Tam ölçeğin %75'i / Tam ölçeğin %65'i / Tam ölçeğin %100'ü
75% of full scale / 65% of full scale / 100% of full scale

Basınç Elemanı / Pressure Element :

Bakır alaşımı / Paslanmaz Çelik - Copper alloy / Stainless Steel

Doğruluk / Accuracy :

Tam ölçeğin %1,6'sı, Tam ölçeğin %1,0'ı, Tam ölçeğin %2,5'i /
1.6% of full scale, 1.0% of full scale, 2.5% of full scale

Pencere / Window :

Gösterge Camı / Emniyet Camı - Instrument Glass / Safety Glass

Kasa / Case:

Mat SS304 / Mate SS304 - Mat 316 / Mate SS316



PNÖMATİK AKTÜATÖRLER

PNEUMATIC ACTUATORS





**Pnömatik Aktüatörlü
Dişli Küresel Vana**
Threaded Ball Valve With
Pneumatic Actuator



**Pnömatik Aktüatörlü
Flanşlı Küresel Vana**
Flanged Ball Valve With
Pneumatic Actuator



**Pnömatik Aktüatörlü 3
Yollu Küresel Vana**
3 Way Ball Valve With
Pneumatic Actuator



**Pnömatik Aktüatörlü
Wafer Tip Kelebek Vana**
Wafer Type Butterfly Valve With
Pneumatic Actuator



**Pnömatik Aktüatörlü
Lug Tip Kelebek Vana**
Lug Type Butterfly Valve With
Pneumatic Actuator



**Pnömatik Aktüatörlü Gıdaya
Uygun Kelebek Vana**
Hygienic SS Butterfly Valve with
Pneumatic Actuator



**Pnömatik Aktüatörlü
Dip Blöf Vanası**
Blowdown Valve
With Pneumatic Actuator



**Pnömatik Aktüatörlü
UPVC Kelebek Vana**
UPVC Butterfly Valve
With Pneumatic Actuator



**Pnömatik Aktüatörlü
UPVC Küresel Vana**
UPVC Ball Valve
With Pneumatic Actuator

ELEKTRİK AKTÜATÖRLER

ELECTRIC ACTUATORS

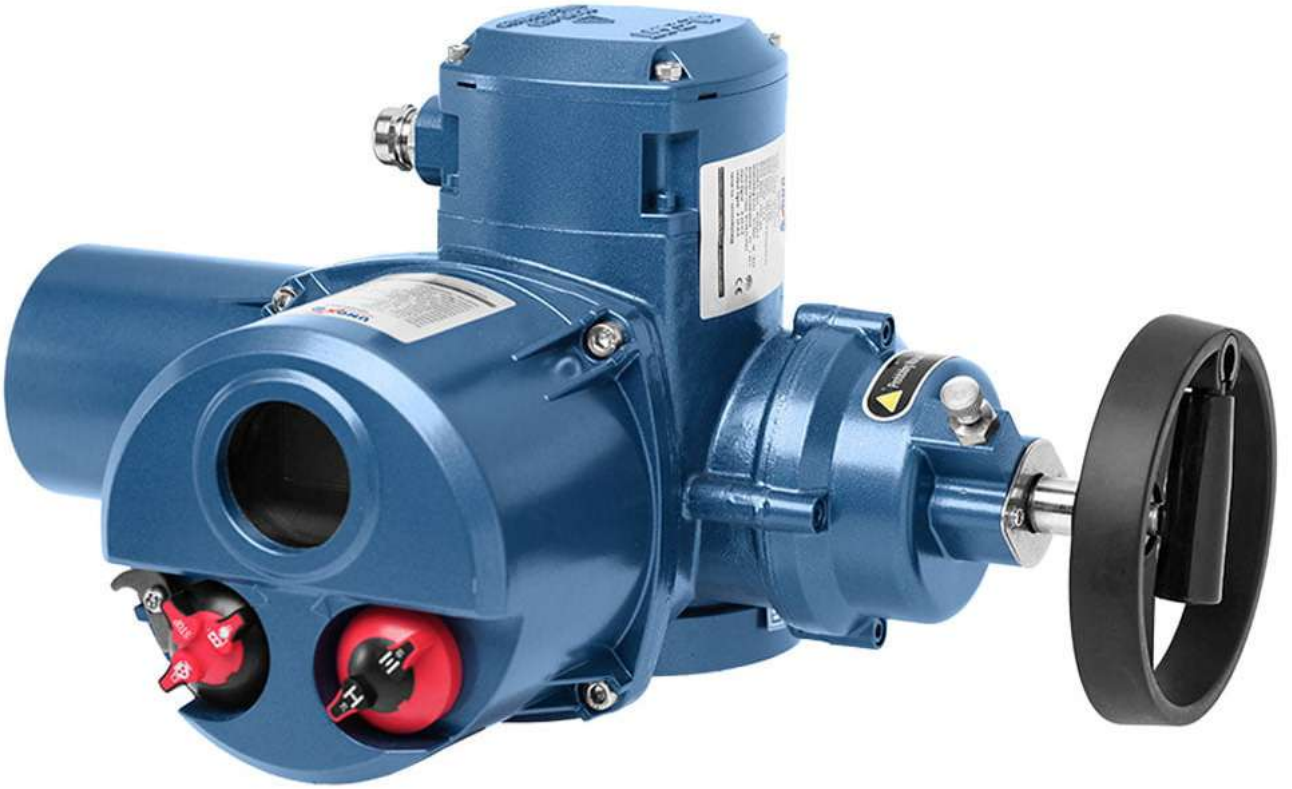



Elektrik Aktüatörler
Electric Actuators



Yerli Elektrik Actuator
Electric Actuators Made in
TÜRKİYE



**Çok Turlu Elektrik
Aktüatörler**
Multi-Turn Electric Actuator



**Elektrik Aktüatörlü Dişli
Küresel Vana**
Threaded Ball Valve With
Electric Actuator



**Elektrik Aktüatörlü
Flanşlı Küresel Vana**
Flanged Ball Valve With Electric
Actuator



**Elektrik Aktüatörlü
UPVC Kelebek Vana**
UPVC Butterfly Valve with
Electric Actuator



**Elektrik Aktüatörlü
Wafer Tip Kelebek Vana**
Wafer Type Butterfly Valve With
Electric Actuator



**Elektrik Aktüatörlü Lug
Tip Kelebek Vana**
Lug Type Butterfly Valve With
Electric Actuator



**Elektrik Aktüatörlü
UPVC Küresel Vana**
UPVC Ball Valve with
Electric Actuator

VANALAR

VALVES





Flanşlı Glob Vana
Flanged Globe Valve



Metal Yataklı Sürgülü Vana
Metal Seated Gate Valve



Elastomer Yataklı Sürgülü Vana
Resilient Seated Gate Valve



Dövme Çelik Sürgülü Vana
Forged Steel Gate Valve



Dövme Çelik Glob Vana
Forged Steel Globe Valve



Dövme Çelik Çekvalf
Forged Steel Check Valve



DBB Vanalar
DBB Valves



Pirinç Küresel Vana
Brass Ball Valve



Enstrümantasyon Küresel Vanalar
Instrumentation Ball Valves



**3 Parçalı Pik / Sfero
Döküm Küresel Vana**
3 pcs Casting Ball Valve



**2 Parçalı Pik / Sfero
Döküm Küresel Vana**
2 pcs Casting Ball Valve



Demontaj Parçası
Dismantling Part



Çift Klapeli Çekvalf
Dual Plate Check Valve



Çalpara Çekvalf
Swing Check Valve



**Karbon Çelik Monoblok
Küresel Vana**
Carbon Steel Monoblock Ball Valve



Valf Manifoldları
Valve Manifolds



**Yüksek Basınç
Küresel Vana**
High Pressure Ball Valve



Enstrumantasyon Çekvalf
Instrumentation Check Valve



İğneli Vanalar
Needle Valve



Pirinç Disko Çekvalf
Brass Disco Check Valve



Flanşlı Pislik Tutucu
Flanged Strainer



Doğalgaz Küresel Vana
Naturalgas Ball Valve



Pirinç Pislik Tutucu
Brass Y-Strainer



Pirinç Yaylı Çekvalf
Brass Spring Check Valve



Pirinç Çalpara Çekvalf
Brass Swing Check Valve



Paslanmaz Dişli Emniyet Ventili
Stainless Steel Threaded Safety Valve



Paslanmaz Çelik Monoblok Küresel Vana
Stainless Steel Monoblock Ball Valve

SOLENOID VALFLER

SOLENOID VALVES





Genel Maksat Solenoid Vanalar
General Purpose Solenoid Valves



Yüksek Basınç Solenoid Vanalar
High Pressure Solenoid Valves



Buhar Solenoid Vanalar
Solenoid Valves For Steam



Paslanmaz Genel Maksat Solenoid Vanalar
Stainless Steel General Purpose Solenoid Valves



Paslanmaz Yüksek Basınç Solenoid Vanalar
Stainless Steel High Pressure Solenoid Valves



Paslanmaz Buhar Solenoid Vanalar
Stainless Steel Steam Solenoid Valves



Paslanmaz Takoz Gövde Solenoid Vanalar
Stainless Steel Wedge Body Solenoid Valves



Motorize Solenoid Vanalar
Motorized Solenoid Valves



Tank Altı Kazan Boşaltma Solenoid Vanaları
Drain Solenoid Valves

KONDESTOPLAR

STEAM TRAPS





Şamandıralı Kondenstop
Float Steam Trap



Termodinamik Kondenstop
Thermodynamic Steam Trap



Ters Kovalı Kondenstop
Inverted Bucket Steam Trap



Paslanmaz Termodinamik Kondenstop
Stainless Steel Thermodynamic Steam Trap



Termostatik Kondenstop
Thermostatic Steam Trap



Manyetik Seviye Göstergesi
Magnetic Level Gauge



Vakum Kırıcı
Vacuum Breaker



Emniyet Ventili
Safety Valve



Camlı Akış Göstergesi
Flow Indicator

KONTROL VANALARI CONTROL VALVES





**Pnömatik Pistonlu
Kontrol Vanası**
Pneumatic Piston Control Valve



**Y-Tipi Pnömatik
Pistonlu Vana**
Y-Type Pneumatic Angle Seat
Valve



**Y-Tipi Pnömatik
Pistonlu Flanşlı Vana**
Y-Type Pneumatic Angle Seat
Flanged Valve



**2 Yollu Pnömatik Kontrol
Vanası**
2 Way Pneumatic Control Valve



**2 Yollu Pnömatik Kızgın
Yağ Kontrol Vanası**
2 Way Pneumatic Control Valve
For Hot Oil



**3 Yollu Pnömatik
Kontrol Vanası**
3 Way Pneumatic Control Valve



Dip Blöf Kontrol Vanası
Blowdown Globe Control Valve



**3 Yollu Pnömatik On-
Off Kızgın Yağ Vanası**
3 Way Pneumatic On-Off Hot Oil
Valve



**3 Yollu Pnömatik Oransal
Kızgın Yağ Vanası**
3 Way Pneumatic Proportional
Hot Oil Valve



2 Yollu Motorlu Kızgın Yağ Vanası
2 Way Motorized Control Valve for Hot Oil



2 Yolu Motorlu Kontrol Vanası
2 Way Motorized Control Valve



3 Yollu Motorlu Kızgın Yağ Kontrol Vanası
3 Way Motorized Control Valve for Hot Oil



3 Yollu Motorlu On-Off Kontrol Vanası
3 Way Motorized On-Off Control Valve



Basınç Düşürücü Kontrol Vanası
Pressure Reducing Control Valve



Basınç Sabitleme Kontrol Vanası
Pressure Stabilizing Control Valve



Debi Kontrol Vanası
Flow Control Valve



Seviye Kontrol Vanası – Elektrik Flatörlü
Level Control Valve – Electric Float Valve



Seviye Kontrol Vanası – Flatörlü
Level Control Valve – Float



Elektrik Tip Deluge Vana
Electric Type Deluge Valve



Solenoid Kontrol Vanası
Solenoid Control Valve



Yükselen Milli Vanalar
Rising Stem Gate Valves



Akış Anahtarları
Flow Switches



İzlenebilir Kelebek Vanalar
Traceable Butterfly Valves



Kuru Tip Deluge Vana
Dry Type Deluge Valve



KELEBEK VANALAR

BUTTERFLY VALVES





Wafer Tip Kelebek Vana
Wafer Type Butterfly Valve

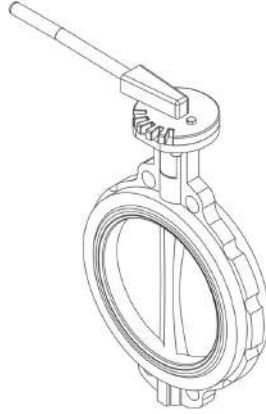

HAND LEVER



**HANDWHEEL
WITH GEARBOX**



**ELECTRIC
ACTUATOR**

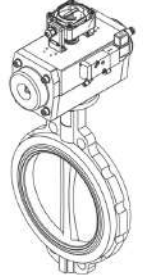

**PNEUMATIC
ACTUATOR**



Lug Tip Kelebek Vana
Lug Type Butterfly Valve

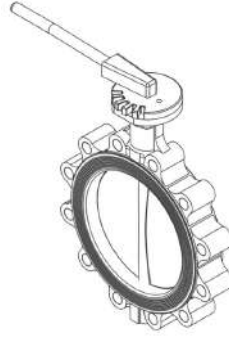

HAND LEVER



**HANDWHEEL
WITH GEARBOX**



**ELECTRIC
ACTUATOR**

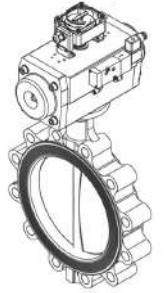

**PNEUMATIC
ACTUATOR**



**Gıdaya Uygun
Paslanmaz Kelebek Vana**
Stainless Steel Butterfly Valve



**Pnömatik Pistonlu Bıçak
Sürgülü Vana**
Pneumatic Piston Knife Gate Valve



**Manuel Bıçak Sürgülü
Vana**
Manuel Knife Gate Valve

PASLANMAZ GRUBU

STAINLESS STEEL PRODUCTS





2 Parçalı Dişli Paslanmaz Küresel Vanalar
2 pcs Threaded Stainless Steel Ball Valves



2 Parçalı Dişli, Tepe Flanşlı Paslanmaz Küresel Vana
2 Pieces Stainless Steel Threaded Ball Valve With Mounting Pad



3 Parçalı Tepe Flanşlı Paslanmaz Küresel Vana
3 Pieces Stainless Steel Ball Valve With Mounting Pad



3 Yollu Tepe Flanşlı Paslanmaz Küresel Vana
3 Way Stainless Steel Ball Valve With Mounting Pad



2 Parçalı, Flanşlı Paslanmaz Küresel Vana
2 Pieces Stainless Steel Flanged Ball Valve With Mounting Pad



Paslanmaz Pislik Tutucu
Stainless Steel Y-type Strainer



Paslanmaz Disko Çekvalf
Stainless Steel Disco Check Valve



Paslanmaz Çalpara Çekvalf
Stainless Steel Swing Check Valve



Wafer Çekvalf
Wafer Type Check Valve

TUBE, BORU VE KAYNAK
BAĞLANTI ELEMANLARI
TUBE, PIPE & WELD FITTINGS





**Çift Yüksüklü
Paslanmaz Erkek Rekor**
Male Connector



**Çift Yüksüklü
Paslanmaz Dişi Rekor**
Female Connector



**Çift Yüksüklü
Paslanmaz Bölmeli
Erkek Rekor**
Bulk Head Male Connector

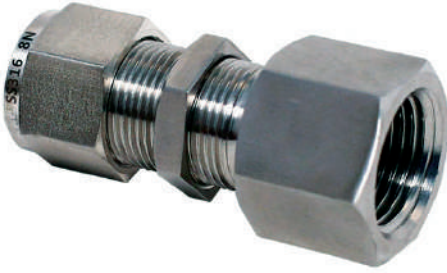

**Çift Yüksüklü
Paslanmaz Bölmeli
Dişi Rekor**
Bulk Head Female Connector

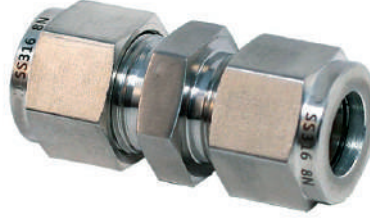

**Çift Yüksüklü
Paslanmaz Eşit Rekor**
Equal Union



**Çift Yüksüklü Paslanmaz
Eşit Redüksiyon**
Unequal Union



**Çift Yüksüklü
Paslanmaz Birleştirici**
Bulk Head Union



**Çift Yüksüklü
Paslanmaz Kross**
Equal Union Cross



**Çift Yüksüklü Paslanmaz
Erkek Dirsek**
Male Elbow



**Çift Yüksüklü
Paslanmaz Dişi Dirsek**
Female Elbow



**Çift Yüksüklü
Paslanmaz Dirsek**
Union Elbow



**Çift Yüksüklü
Paslanmaz Birleştirmeli
Dirsek**
Bulk Head Union Elbow



**Çift Yüksüklü
Paslanmaz Eşit Tee**
Union Tee

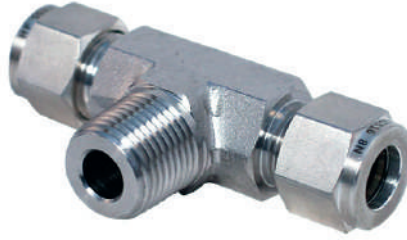

**Çift Yüksüklü
Paslanmaz Erkek Tee**
Male Branch Tee



**Çift Yüksüklü Paslanmaz
Dişi Tee**
Female Branch Tee



**Kapak (Tüp Sonu
Kapanışı)**
Tube Cap

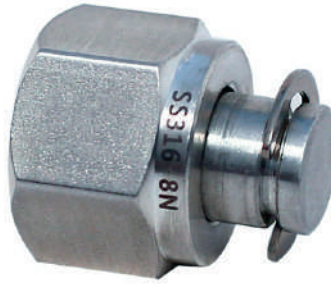

Fiş (Fitting Uç Kapatma)
Tube Plug



Hortum Adaptörleri
Hose Adapters



**Boru Tipi-Kollektör
Hava Dağıtıcıları**
Air Header Distribution Manifolds



**Çubuk Tipi-Kollektör
Hava Dağıtıcıları**
Air Header Distribution Manifolds



Paslanmaz Borular
Stainless Steel Tubings



**Paslanmaz Boru
Fittingsleri - Erkek Tee**
Male Tee



**Paslanmaz Boru
Fittingsleri - Dişi Tee**
Female Tee



**Paslanmaz Boru
Fittingsleri - Erkek Nipel**
Hex Nipple



**Paslanmaz Boru
Fittingsleri - Kaplin**
Full Coupling



Paslanmaz Kör Tapa
Hex Plug



Dişi Adaptör
Female Adapter



Şifon
Syphon



Valf Sızdırmazlık
Enjektörü
Valve Sealant Injector



Valf Fitting - Çekvalf
Check Valve



Hava Alma Bağlantı
Soketi Vidalı Tip
Bleed Fitting Socket Screw Type



Çelik (Siyah) /
Paslanmaz Çelik
Kaynak Bağlantı Elemanları
Weld Fittings



Paslanmaz Flanşlar
Stainless Steel Flanges



Karbon Çelik Flanşlar
Carbon Steel Flanges



Vana Temizleme Yağı
Valve Cleaner Flush



Vana Sızdırmaz Macunu
Valve Lubricant Grease



**Vana Tamir Kitleri ve
Yedek Parçaları**
Valve Parts



Boru Bükücü
Tube Bender



Boru Kesici
Tube Cutter



**Tek Yüksüklü Galvaniz Kaplı /
Paslanmaz Rakorlar**
Single Ferrule Galvanized / Stainless Steel
Tube Fittings

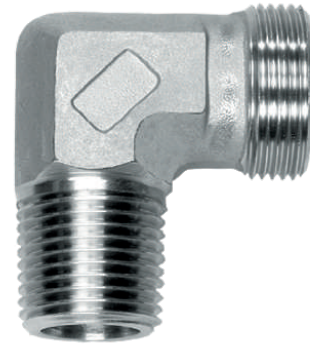

**Galvaniz Kaplı /
Paslanmaz Dirsek Rakor**
Elbow



KOMPANSATÖRLER VE HORTUMLAR

EXPANSION JOINTS AND HOSES





**Dişli Kauçuk
Kompansatör**
Threaded Rubber Expansion
Joint

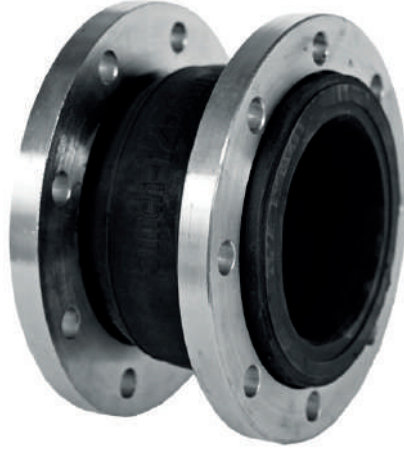

**Flanşlı Kauçuk
Kompansatör**
Flanged Rubber Expansion Joint



**Metal Körüklü Laynersiz
Kompansatör**
Metal Bellow Expansion Joint
Without Layner



**Metal Körüklü Laynerli
Kompansatör**
Metal Bellow Expansion Joint
With Layner



**Limit Rotlu Metal
Körüklü Kompansatör**
Vibration Absorber Metal
Expansion joint



**Çelik Flanşlı Kauçuk
Kompansatör**
Carbon Steel Flanged Rubber
Expansion Joint



Buhar Separatörü
Steam Separator



Paslanmaz Flanş
Stainless Steel Flange

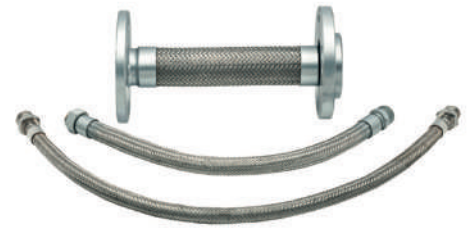

Esnek Metal Hortum
Flexiabile Metal Hoses



IP Konvertör
IP Converter



Ex-Proof Limit Switch Box
Ex-Proof Limit Switch Box



Limit Switch Box
Limit Switch Box



Namur Yön Valfi
Namur Solenoid Valve

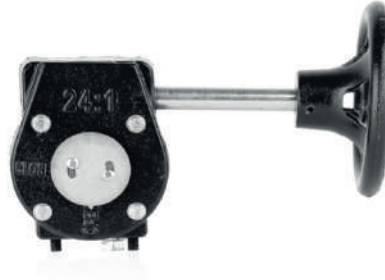

Redüktör / Gearbox
Reductor / Gearbox



Pnömatik Pozisyoner
Pneumatic Positioner



Akış Anahtarı
Flow Switch



Paslanmaz Mini Seviye Şarteli
Stainless Mini Level Switch



Paslanmaz Seviye Tank Şamandırası
Stainless Level Tank Float Switch



Prosestat
Pressure Switch



Vakumostat
Vacuum Switch



Higrostat
Hygrostat



Seviye Şalteri
Level Switch



Seviye Şalteri
Level Switch



Seviye Elektrodu
Level Electrode



Dişli Kazan Tağdiye Cihazı
Threaded Mechanical Level Controls



Flanşlı Kazan Tağdiye Cihazı
Flanged Mechanical Level Controls



Seviye Elektrodu
Level Electrode

PETROL SAHASI VE AKIŞ HATTI ÜRÜNLERİ

OILFIELD & FLOW LINE PRODUCTS





Çekiç Rakorları
Hammer Unions



Kompansatörler
Expansion Joints



Crossover ve Adaptörler
Crossovers & Adapters



Ring Joint Gasket
Oval, RX, BX, Hexagonal
Ring Joint Gasket



Boru Bağlantı Parçaları
Pipe Fittings



Choke Vana
Choke Valve



Swivel Joints
Swivel Joints



Integral Fittings
Integral Fittings



Plug Vanalar
Plug Valves

BASINÇLI EKİPMANLAR PRESSURE VESSELS





Kokulandırma Tankı
Odouriser Tank



Kolay Açılır Kapak
QOC / Quick Open Closures

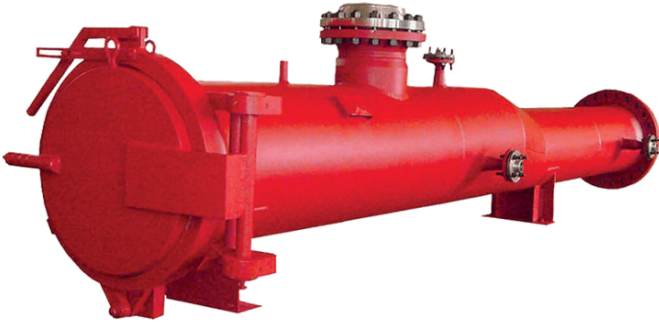

Pig Traps
Pipeline Pigging Systems
Pig Launcher, Receiver & Valves



Pig Sinyalci
Pipeline Pigging Systems
Pig Indicators & Signallers



**KALİTELİ ÜRÜNLERİ,
UYGUN FİYATA VE EN İYİ HİZMETLE
SUNMAKTA KARARLIYIZ.**

COMMITTED TO PROVIDING QUALITY PRODUCTS
WITH THE BEST SERVICE AND AFFORDABLE PRICES.

MEGA
KONTROL

ÜÇEVLER MAHALLESİ
ÖĞRETMEN CADDESİ
NO: 24/B, NİLÜFER, BURSA
P.C.: 16120

★ TÜRKİYE

info@megakontrol.com

www.megakontrol.com

